

基準公差表	
L ≤ 10	±0.50
10 < L ≤ 60	±0.80
60 < L ≤ 100	±1.00
100 < L	±1.50
ANGULAR DIMENSION	±2°

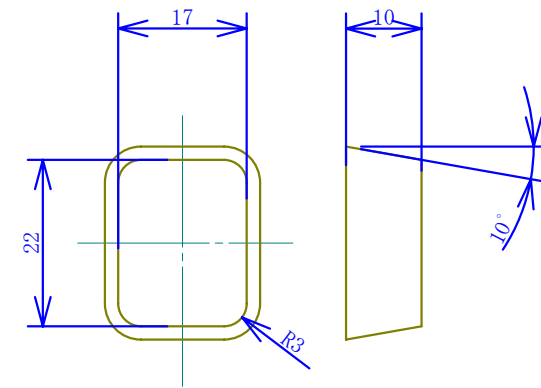

ポケット寸法

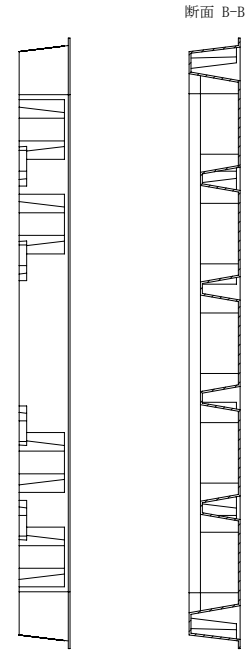
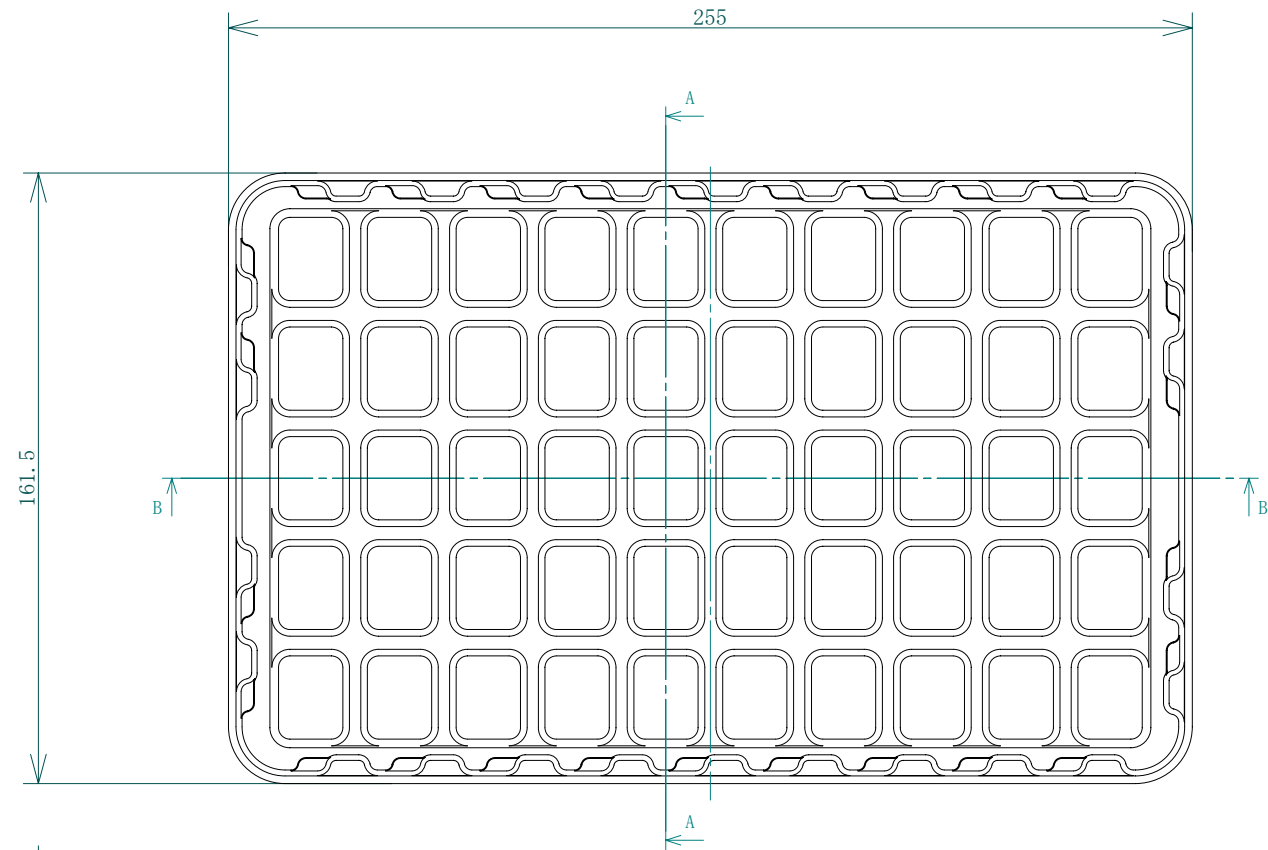
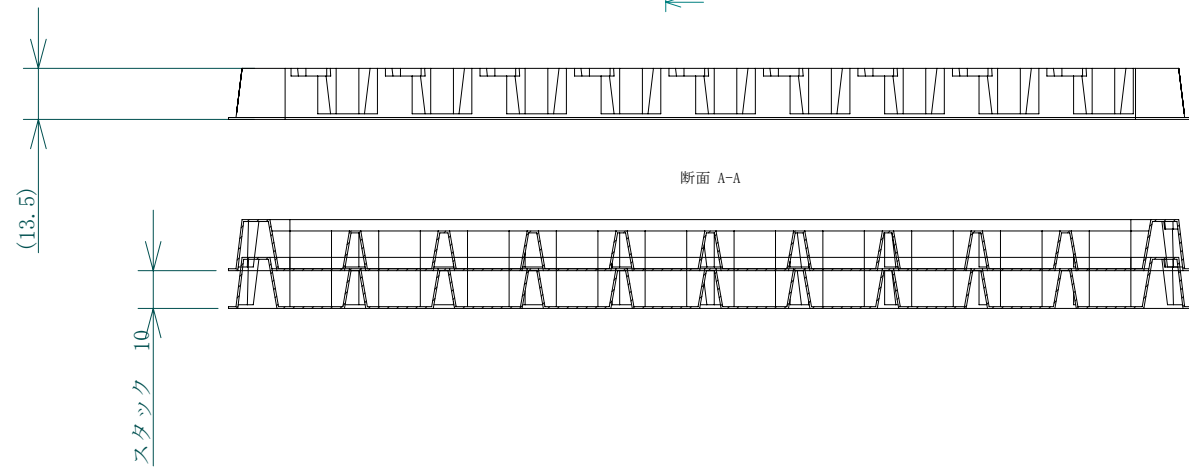

TITLE e-TRAY		
FINISH 255×161.5 17×22 S10 50P		
DATE 2009/02/01	MATERIAL NAME APETt=0.5mm	
SCALE 1:2	DESIGN BY	CHECKED BY
	DRAWN BY suzuki	APPROVED BY

TOKYOPACK CO., LTD.

部品番号