

基準公差表	
L ≤ 10	±0.50
10 < L ≤ 60	±0.80
60 < L ≤ 100	±1.00
100 < L	±1.50
ANGULAR DIMENSION	±2°

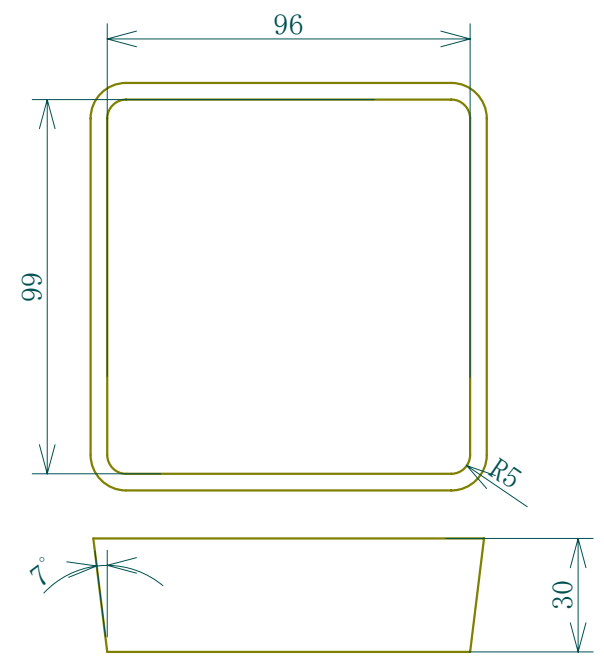

ポケット寸法

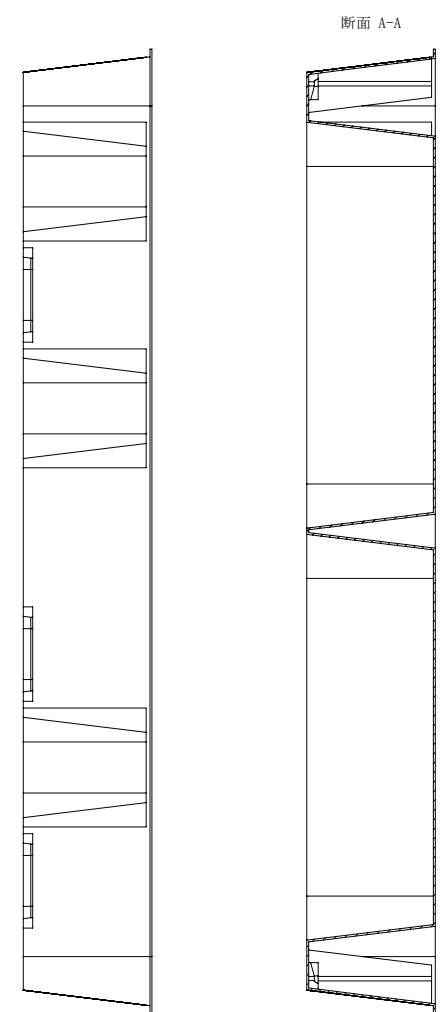
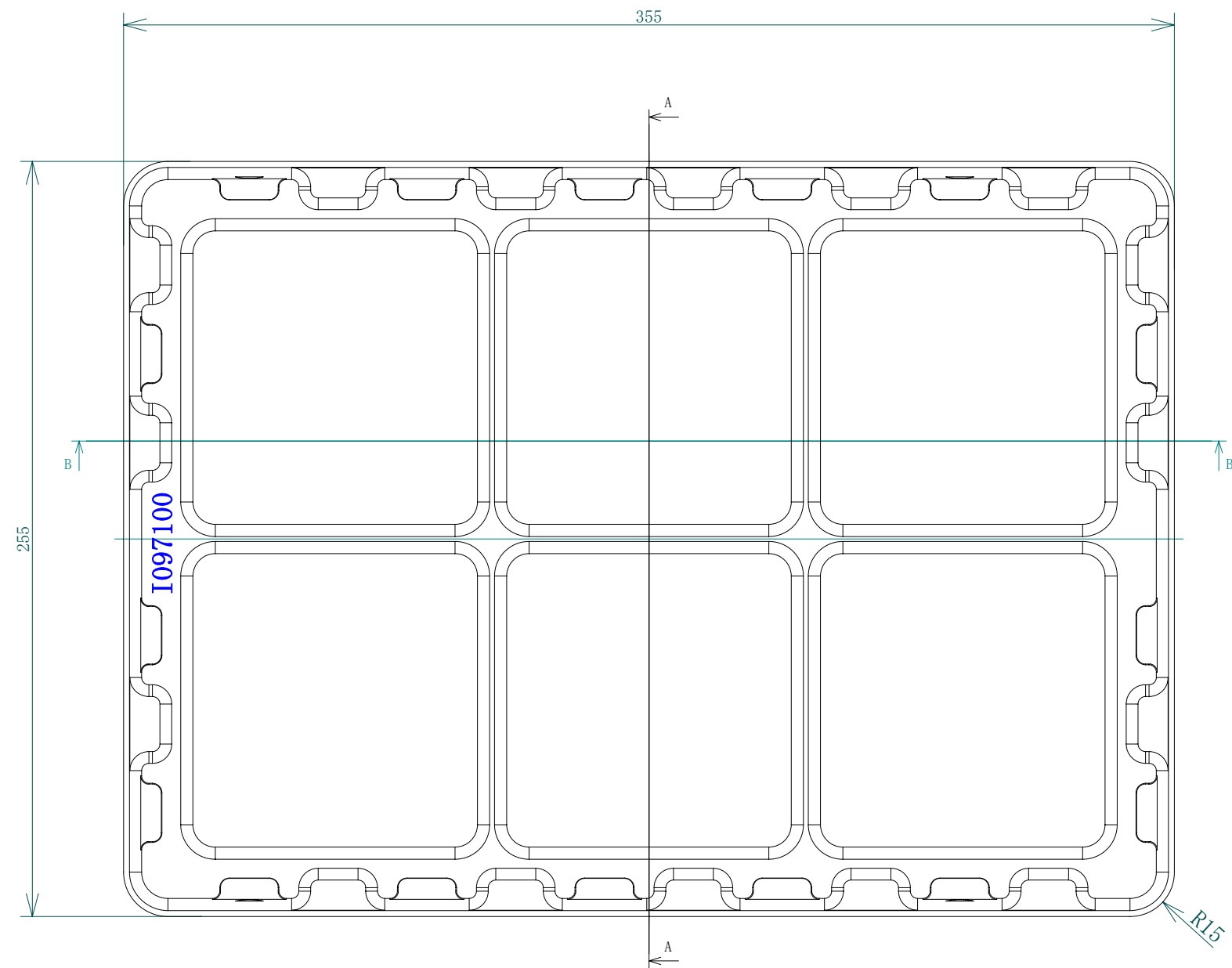
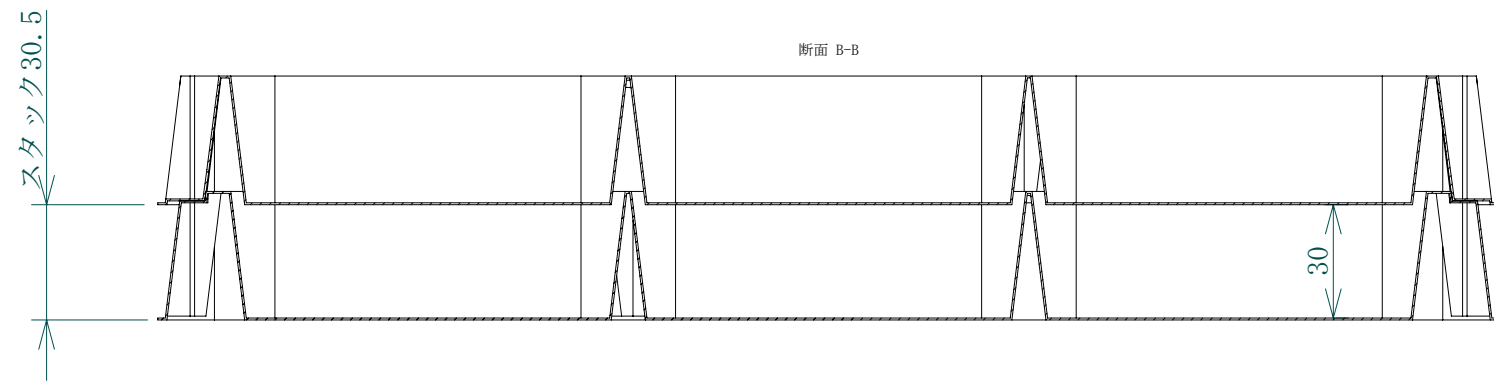
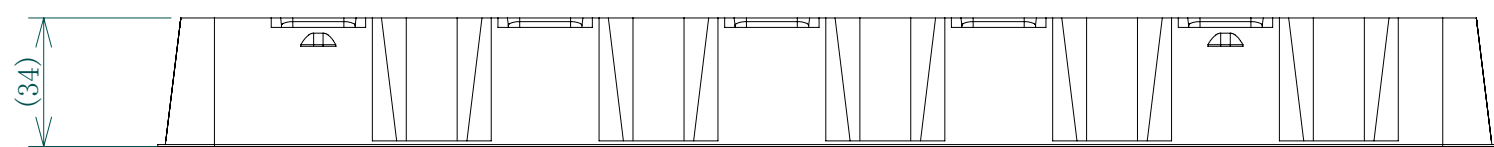

TITLE <b>I 097100</b>		
FINISH <b>355×255 96×99 S30 6P</b>		
DATE 2024/07/10	MATERIAL NAME t=0.5mm	
SCALE 1:2	DESIGN BY	CHECKED BY
	DRAWN BY suzuki	APPROVED BY

TOKYOPACK CO., LTD.

部品番号