

番号 No.	年月日 DATE	変更REVISIONS・記事CONTENTS	変更 REVISED BY	承認 APPROVED BY
△				
△				
△				

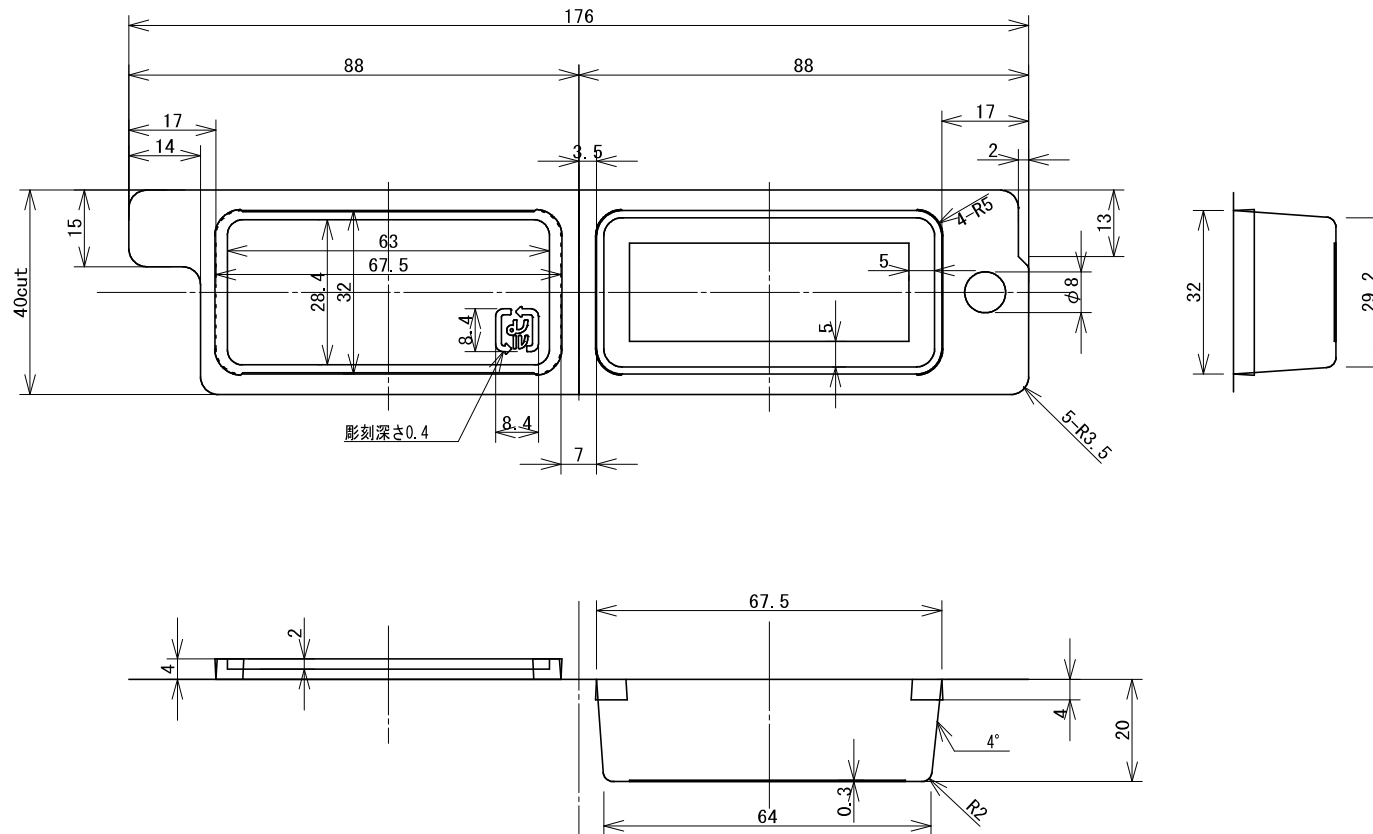

会社名 CUSTOMERS NAME		作成日 DESIGNED DATE	
		2018. 11. 15	
品名 DRAWING NAME			
CL-3368-2			
材質 MATERIAL	尺度 SCALE	検認 CHECKED BY	承認 APPROVED BY
A-PET t=0.4	1/1		hokao
設計 DESIGNED BY			
hokao			
東京パック株式会社			